

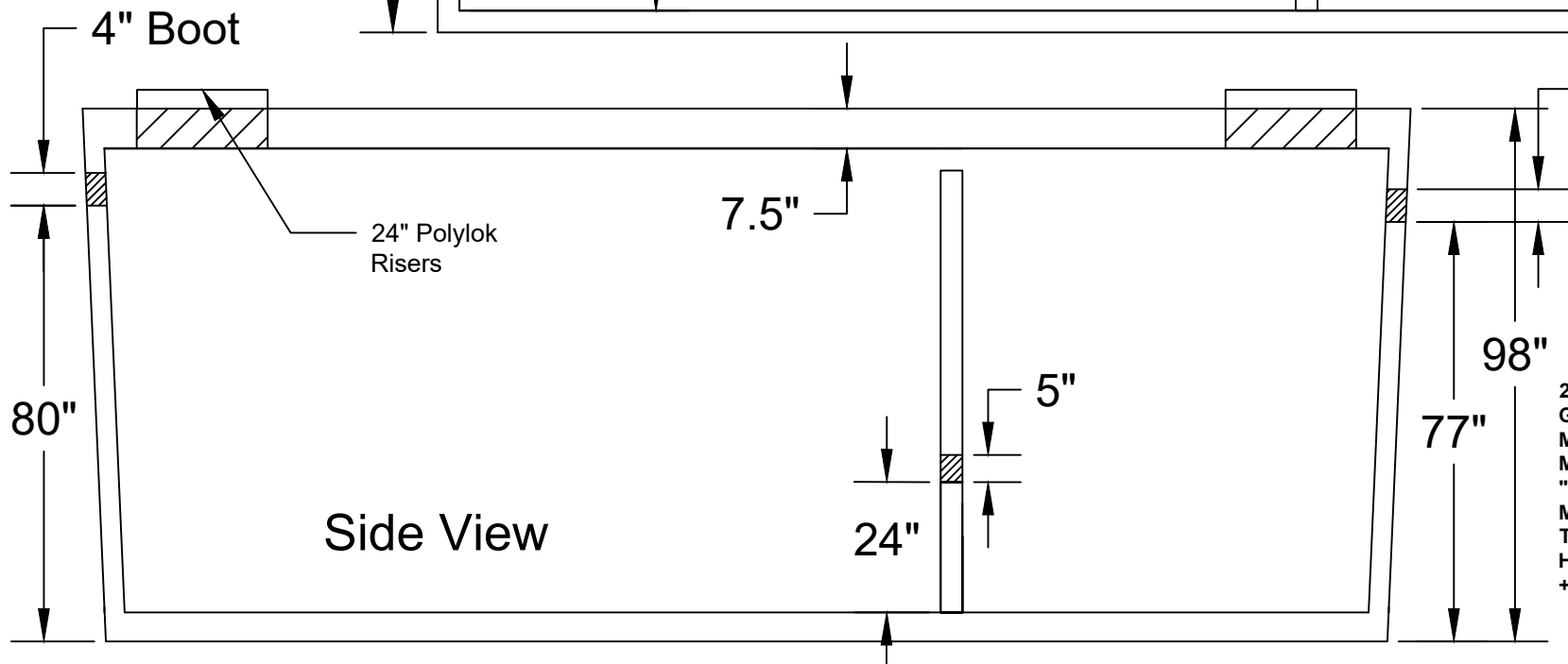

Jarrett Concrete Products 615-792-9332
2012 Hwy 12 South, Ashland City, TN 37015

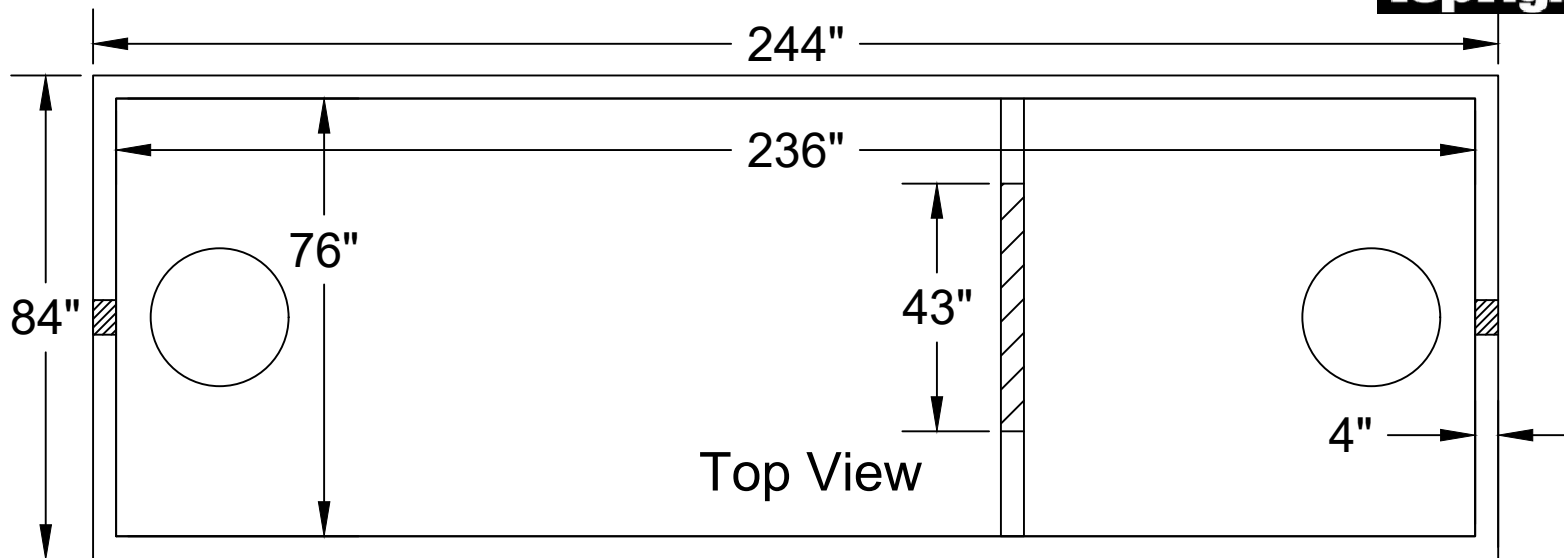

28 Day, 5,000 PSI Concrete
G-60 #4 Rebar @ 12" o.c.e.w.
Meets ASTM C-1227, 990, 923
Monolithic Tank Design
"Top Tight" Patented
May contain fiber in mix design
Tank may be epoxy coated
H-20 Traffic Rated
+/- 1/2" Tolerance

Septic Tank 5000 Gallon (4" Boots)

Date: 9-29-2023 Drawn By: L.Owen Weight: 40,852 lbs

TANKS SOLD BY JCP MUST BE WATER TESTED WITHIN 5 BUSINESS DAYS FROM THE TIME WE SET THE TANK. IF THE TANK IS NOT TESTED WITHIN 5 BUSINESS DAYS, IT IS ASSUMED YOU HAVE OPTED FOR A VACUUM TEST AT YOUR EXPENSE. IT'S THE CUSTOMER'S RESPONSIBILITY TO SCHEDULE WATER TEST WITH LOCAL INSPECTOR. DO NOT BACKFILL TANK UNTIL CLEARED BY INSPECTOR.