



Jarrett Concrete Products 615-792-9332
2012 Hwy 12 South, Ashland City, TN 37015

28 Day 6,000 PSI Concrete, G60 Rebar, #4 Rebar @ 9 o.c.e.w. (Floor)
#4 Rebar @ 9" o.c.e.w. (Walls), #5 Rebar @ 9" o.c.e.w. (Lid)
HS20-44 Rated, Pod Volume Varies Between 400-800 Cubic Feet
Rain Ports Can Be Added to Lid and/or Rain Drain can be Added to Floor
Steps Centered to Access Hole, Access Hole Not Needed in Every Pod
Bleed Hole Placement Based On Tailored Pod Configuration
Patent Pending, Heaviest Pick Weight 33,000 lbs



Top View

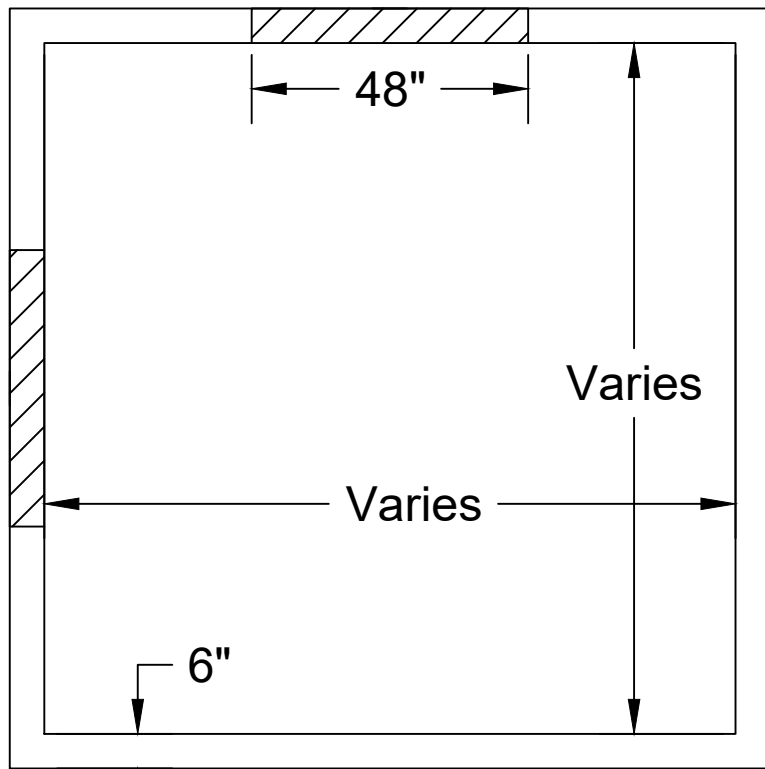

Side View

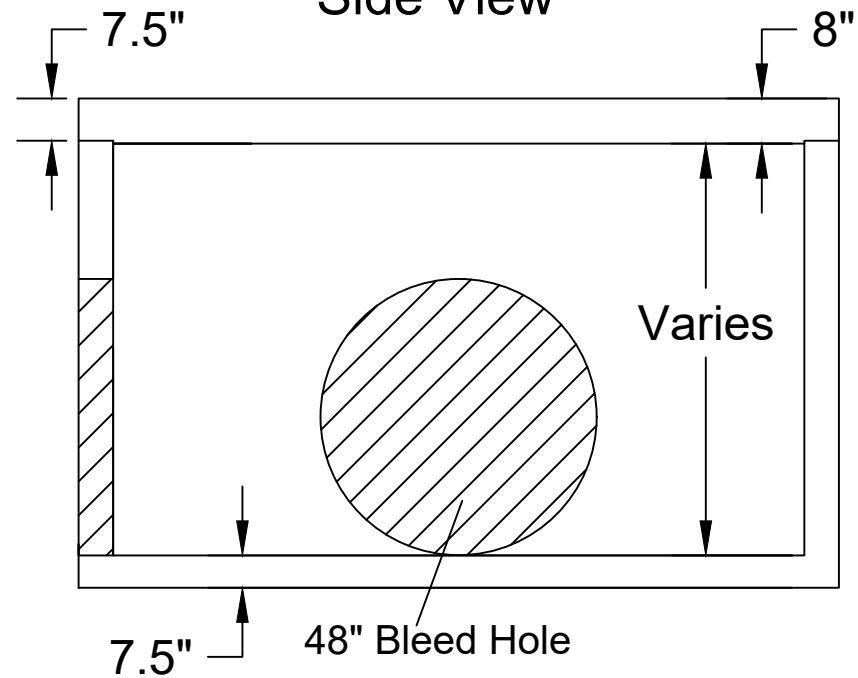

Rain Cave™ Water Detention System

Date: 11-7-2023

Drawn By: L.Owen

Weight: Varies

RC5

