

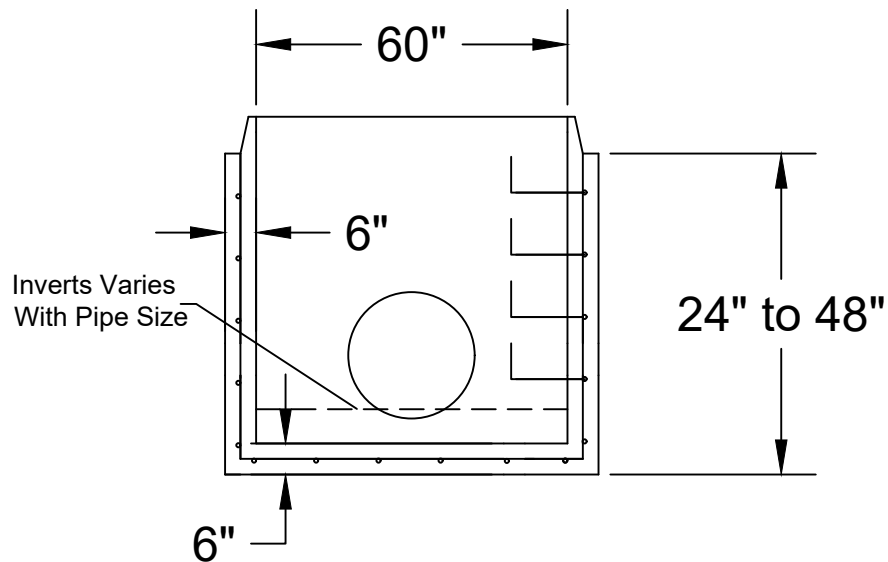

Jarrett Concrete Products 615-792-9332
2012 Hwy 12 South, Ashland City, TN 37015

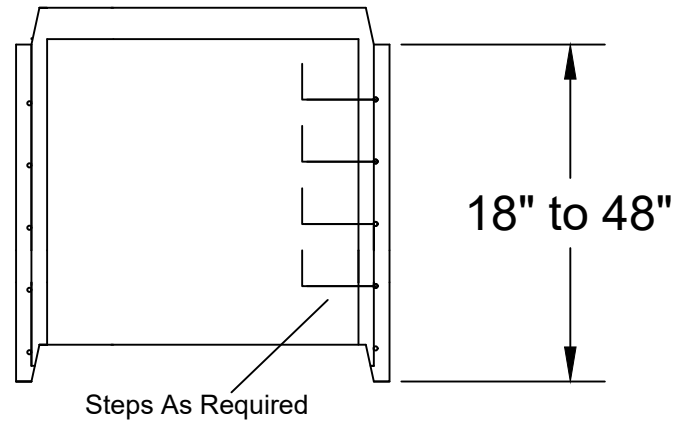

28 Day, 5,000 PSI Concrete
G-60 #4 Rebar @ 12" o.c.e.w.
Meets ASTM C-1227, 990, 923
H-20 Traffic Rated
+/- 1/2" Tolerance
Print not to scale



60" Manhole Base & Riser (Storm)

Date: 11-3-2023

Drawn By: L.Owen

Weight: Varies