

Jarrett Concrete Products 615-792-9332
2012 Hwy 12 South, Ashland City, TN 37015

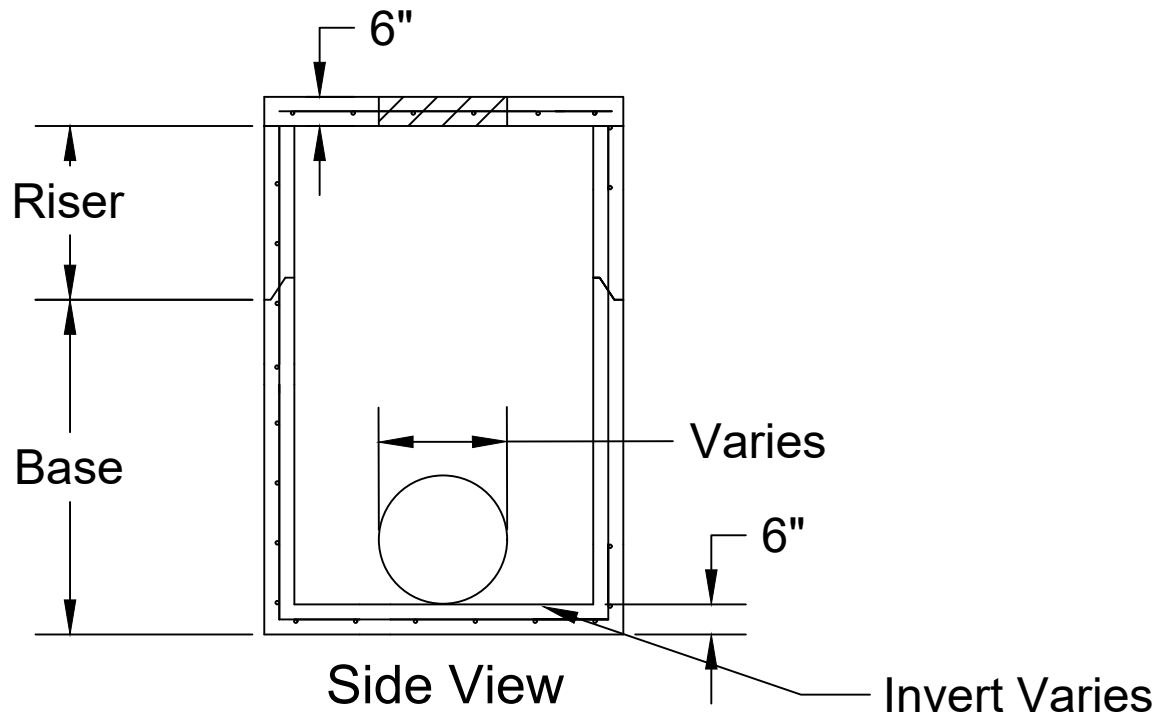

Top View

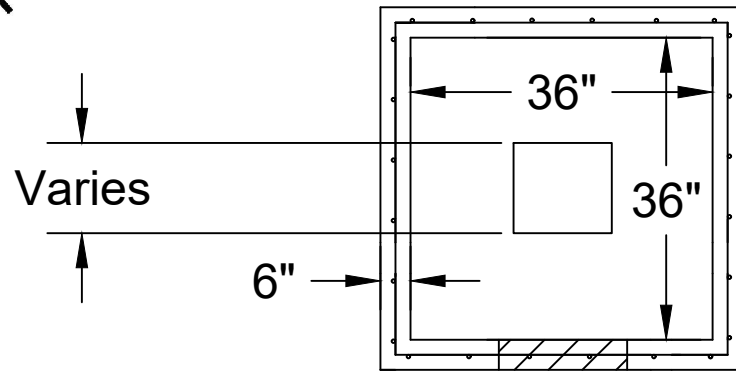

28 Day, 5,000 PSI Concrete
G-60 #4 Rebar @ 12" o.c.e.w.
Meets ASTM C-1227, 990, 923
H-20 Traffic Rated
+/- 1/2" Tolerance
Print not to scale

36" x 36" CI-CB-AD

Date: 11-1-2023 Drawn By: L.Owen Weight: **Varies**