

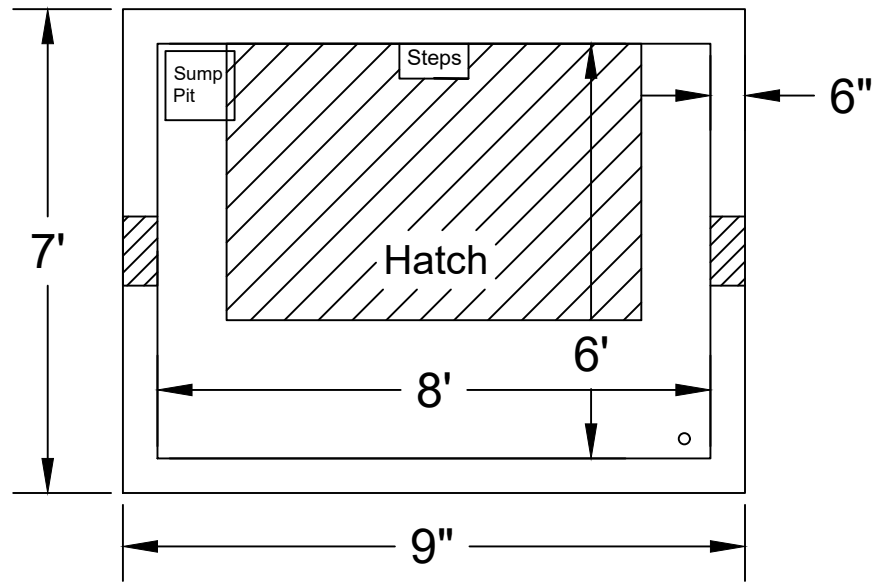

Jarrett Concrete Products 615-792-9332
 2012 Hwy 12 South, Ashland City, TN 37015



Top View



Side View

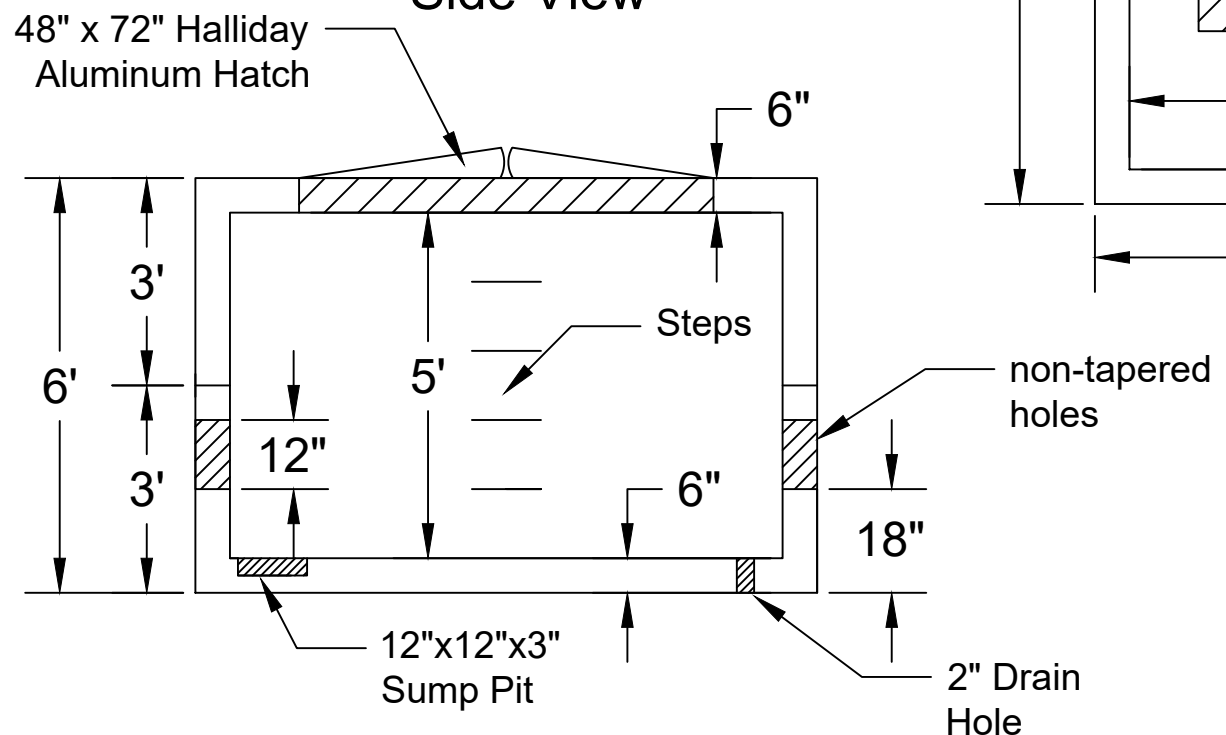

Vault Tag: _____
 Hatch Tag: _____
for internal use

8' x 6' x 5' Metro Meter Vault

28 Day, 5,000 PSI Concrete
 #4 Rebar @ 12" O.C.E.W.
 Meets ATSM C923 & C990
 Steps Centered to Hatch

Heaviest Pick
 Weight 9,803 lbs

Date: 11-8-2023 Drawn By: L.Owen Weight: 17,901 lbs