

Jarrett Concrete Products 615-792-9332
2012 Hwy 12 South, Ashland City, TN 37015

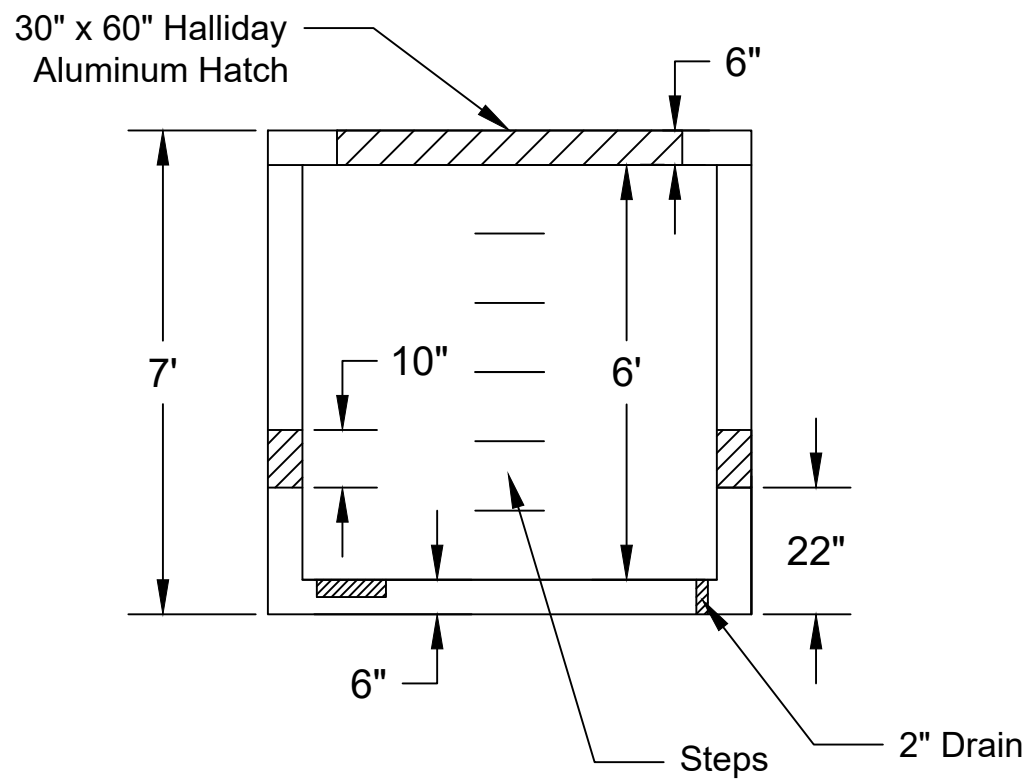

Side View



Top View

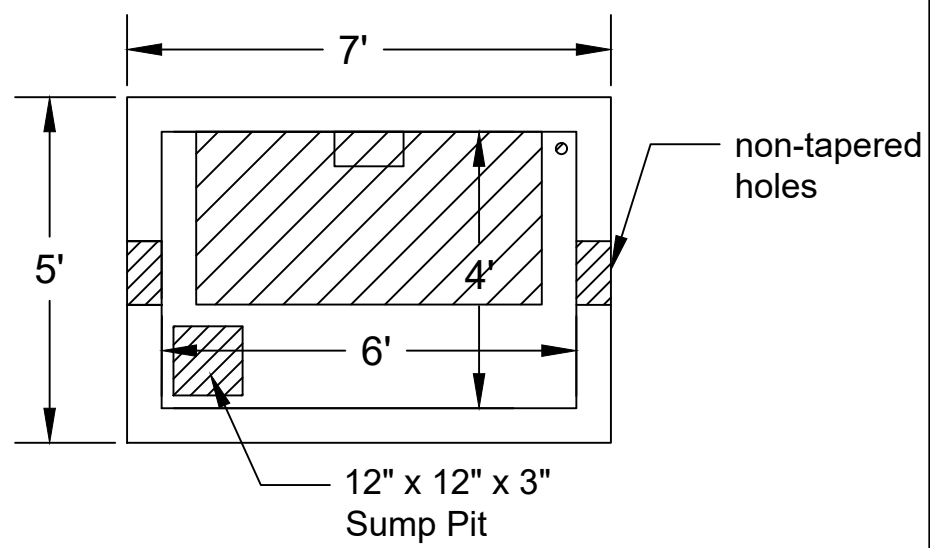

Vault Tag: _____
Hatch Tag: _____
for internal use

6' x 4' x 6' Meter Vault

Date: 11-8-2023 Drawn By: L.Owen Weight: 13,461 lbs

28 Day, 5,000 PSI Concrete
G-60 #4 Rebar @ 12" o.c.e.w.
Meets ASTM C-1227, 990, 923
+/- 1/2" Tolerance

Heaviest Pick
Weight 11,863 lbs