

Jarrett Concrete Products 615-792-9332
2012 Hwy 12 South, Ashland City, TN 37015

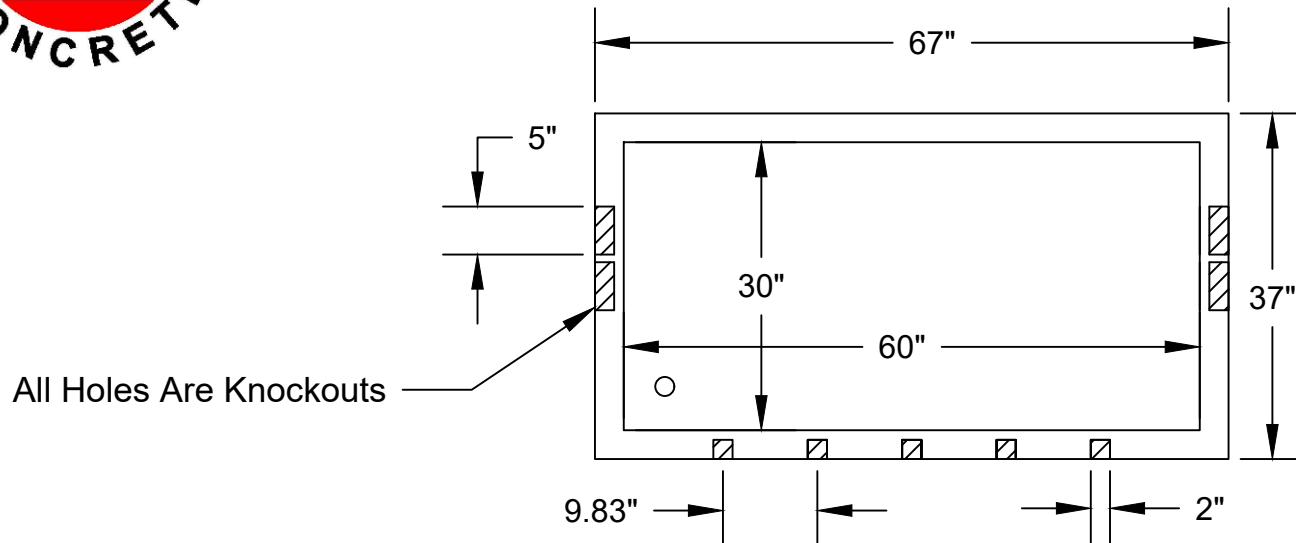

28 Day, 5,000 PSI Concrete
G-60 #3 Rebar @ 12" o.c.e.w.
Meets ASTM C-1227, 990, 923
+/- 1/2" Tolerance
Print Not to Scale

Top View



End View

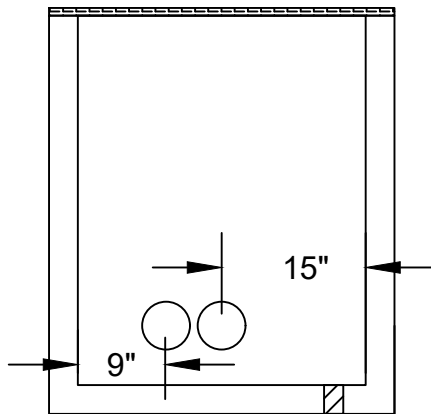

Side View

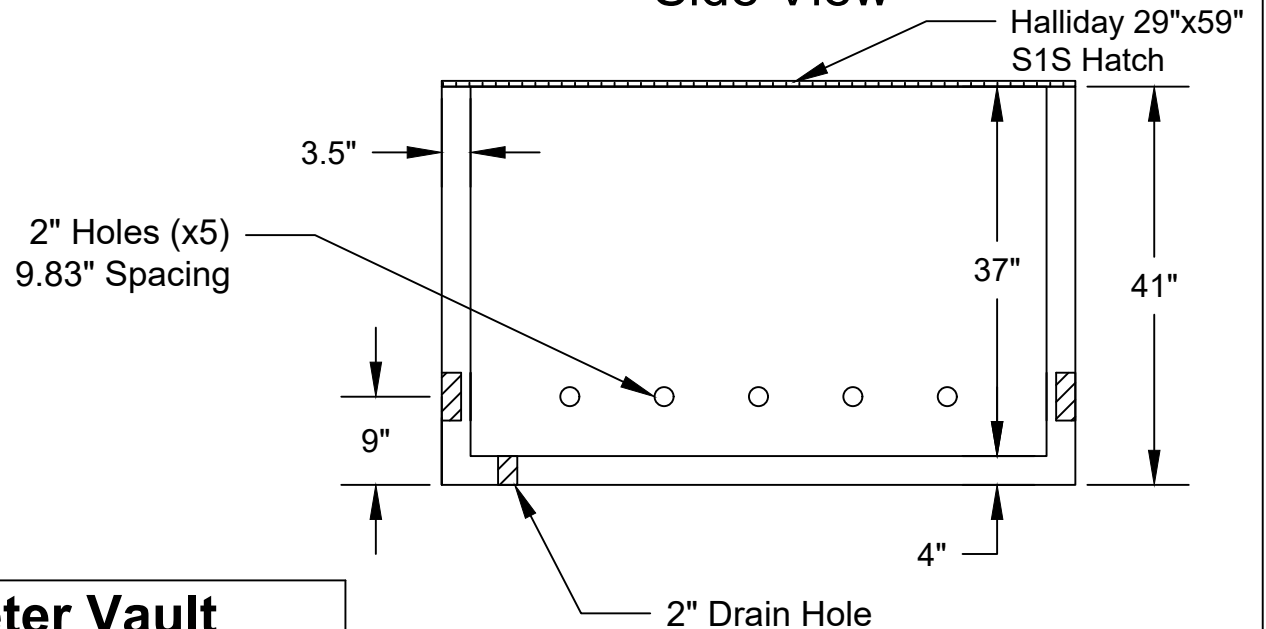

30" x 60" x 37" 5-Gang Meter Vault

Date: 12-5-2024

Drawn By: L.Owen

Approx Empty Vault
Weight: 3,100 lbs