

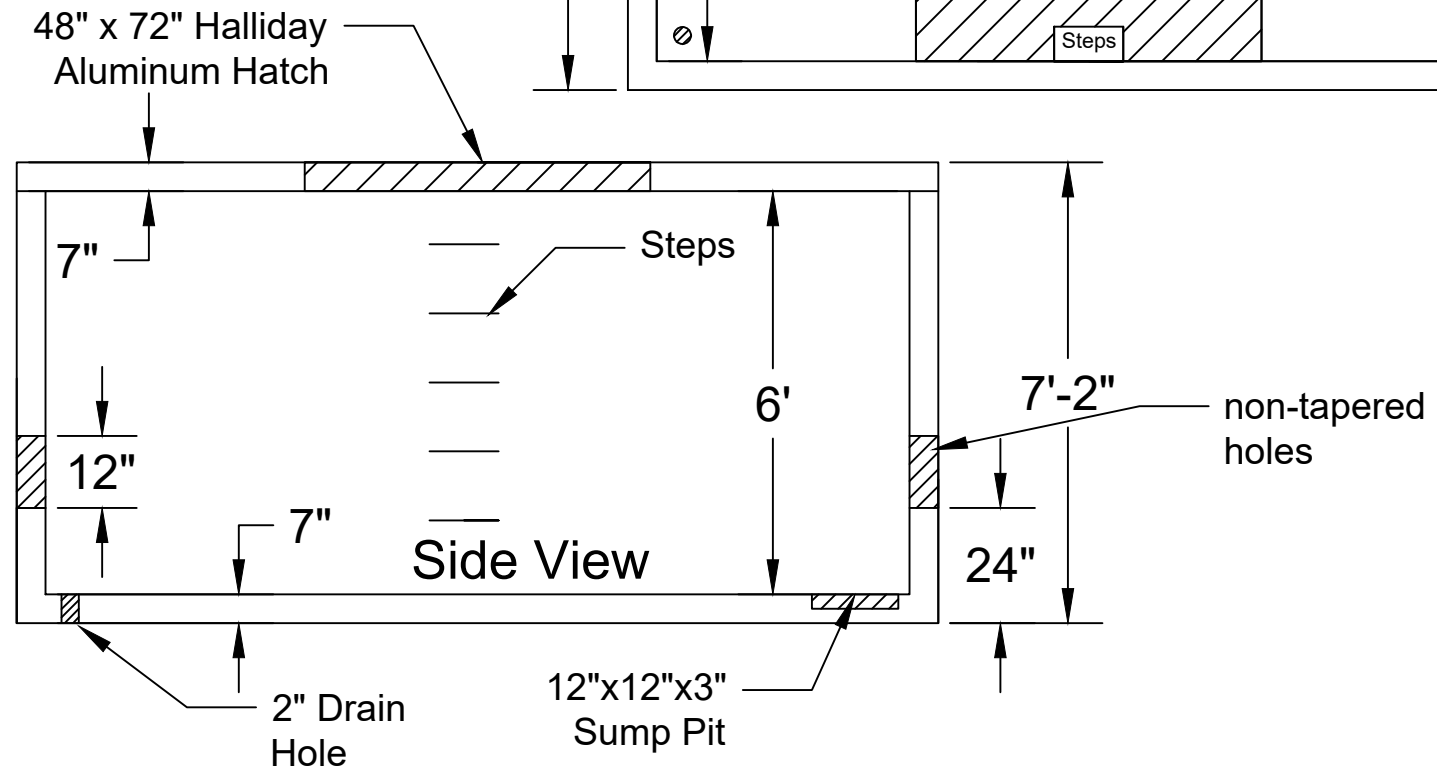

Jarrett Concrete Products 615-792-9332
 2012 Hwy 12 South, Ashland City, TN 37015

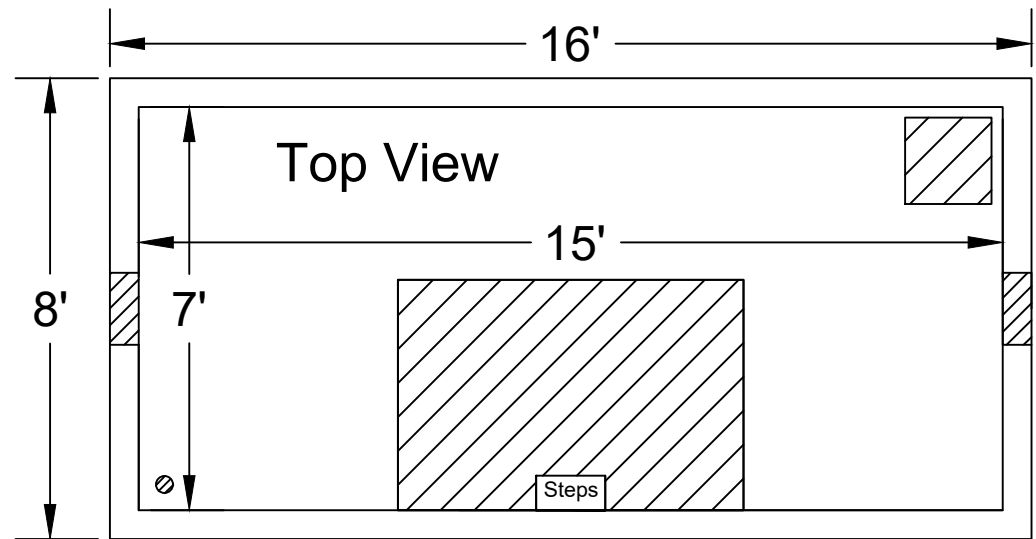

Vault Tag: _____
 Hatch Tag: _____
for internal use

15' x 7' x 6' Meter Vault

Date: 11-10-2023 Drawn By: L.Owen Weight: 39,128 lbs

28 Day, 5,000 PSI Concrete
 G-60 #4 Rebar @ 10" o.c.e.w.
 Meets ASTM C-1227, 990, 923
 +/- 1/2" Tolerance

Heaviest Pick
 Weight 30,202 lbs